

## 2L4U4VX065X06Fwxys4

### Features

- Unique high port count panel antenna for 4G/5G small cell applications
- 20 total connectors to service the 617-906, 1695-2700 and 3300-4200 MHz bands
- Ideal for multi-carrier or 4x4 MIMO deployments
- Fixed tilt options

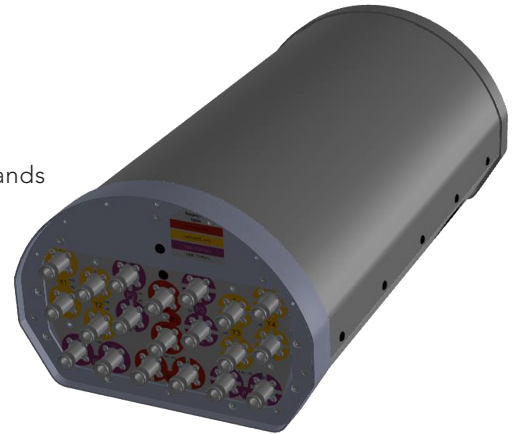

<b>PRODUCT OVERVIEW</b>	Frequency Range (MHz)	(2x) 617-906	(4x) 1695-2700	(4x) 3300-4200
	Array	■ R1, ■ R2	■ Y1, ■ Y2, ■ Y3, ■ Y4	■ P1, ■ P2, ■ P3, ■ P4
	Connector	4 PORTS	8 PORTS	8 PORTS
	Polarization	XPOL	XPOL	XPOL
	Azimuth Beamwidth (avg)	80°	72°	60°
	Electrical Downtilt	0°	2°, 4°, 6°	0°
	Maximum Continuous Power Per Port @ 50° C (122° F)	150 WATTS	125 WATTS	80 WATTS
	Maximum Total Continuous Power at 50° C (122° F)	2240 WATTS		
	Total Connector Count	20 PORTS		
	Connector Type	4.3-10 FEMALE		
Dimensions	635 x 344 x 246 mm (25.0 x 13.5 x 9.7 in)			
Radome Color Options	GREY			

### ELECTRICAL SPECIFICATIONS

■ R1 ■ R2

Frequency Range		MHz	(2x) 617-906	
Frequency Sub-Range		MHz	617-806	806-906
Polarization		---	(2x) ±45°	
Gain	BASTA	dBi	7.7 ± 0.5	7.7 ± 0.9
	MAX	dBi	8.2	8.6
Azimuth Beamwidth (3 dB)		degrees	81.6° ± 6.6°	83.9° ± 15.7°
Elevation Beamwidth (3 dB)		degrees	75.4° ± 12.5°	67.0° ± 22.9°
Electrical Downtilt		degrees	(w) 0°	
Impedance		Ohms	50Ω	
VSWR		---	≤ 1.5:1	
Passive Intermodulation 3rd Order for 2x20 W Carriers		dBc	< -153	
Upper Sidelobe Suppression		dB	N/A	
Isolation	Intraband	dB	> 25	
	Interband	dB	> 28 same band; > 30 different bands	

Quoted performance parameters are provided to offer typical, peak or range values only and may vary as a result of normal testing, manufacturing and operational conditions. Extreme operational conditions and/or stress on structural supports is beyond our control. Such conditions may result in damage to this product. Improvements to products may be made without notice.

## 2L4U4VX065X06Fwxys4

### ELECTRICAL SPECIFICATIONS

■ Y1 ■ Y2 ■ Y3 ■ Y4

Frequency Range	MHz	(4x) 1695-2700				
Frequency Sub-Range	MHz	1695-1880	1850-1990	1920-2200	2300-2700	
Polarization	---	(4x) ±45°				
Gain	BASTA	dBi	10.5 ± 1.2	10.6 ± 1.5	10.9 ± 1.3	11.7 ± 0.8
	MAX	dBi	11.7	12.1	12.2	12.5
Azimuth Beamwidth (3 dB)	degrees	72.5° ± 10.6°	74.1° ± 7.9°	66.7° ± 13.3°	54.8° ± 10.3°	
Elevation Beamwidth (3 dB)	degrees	35.3° ± 3.7°	33.0° ± 3.9°	31.8° ± 3.6°	27.1° ± 3.6°	
Electrical Downtilt	degrees	(x) 2°, 4°, 6°				
Impedance	Ohms	50Ω				
VSWR	---	≤ 1.5:1				
Passive Intermodulation 3rd Order for 2x20 W Carriers	dBc	< -153				
Upper Sidelobe Suppression	dB	N/A				
Isolation	Intraband	dB	> 25			
	Interband	dB	> 28 same band; > 30 different bands			

### ELECTRICAL SPECIFICATIONS

■ P1 ■ P2 ■ P3 ■ P4

Frequency Range	MHz	(4x) 3300-4200			
Frequency Sub-Range	MHz	3300-3550	3550-3700	3700-4200	
Polarization	---	(4x) ±45°			
Gain	BASTA	dBi	10.3 ± 0.7	10.9 ± 0.7	10.7 ± 0.9
	MAX	dBi	11.0	11.6	11.6
Azimuth Beamwidth (3 dB)	degrees	59.2° ± 12.9°	56.8° ± 17.0°	74.7° ± 18.6°	
Elevation Beamwidth (3 dB)	degrees	33.2° ± 4.4°	29.2° ± 2.9°	29.4° ± 4.7°	
Electrical Downtilt	degrees	(y) 0°			
Impedance	Ohms	50Ω			
VSWR	---	≤ 1.5:1			
Passive Intermodulation 3rd Order for 2x20 W Carriers	dBc	-153			
Upper Sidelobe Suppression	dB	N/A			
Isolation	Intraband	dB	> 25		
	Interband	dB	> 28 same band; > 30 different bands		

Quoted performance parameters are provided to offer typical, peak or range values only and may vary as a result of normal testing, manufacturing and operational conditions. Extreme operational conditions and/or stress on structural supports is beyond our control. Such conditions may result in damage to this product. Improvements to products may be made without notice.

## 2L4U4VX065X06Fwxys4

### MECHANICAL SPECIFICATIONS

Antenna	Length	mm (in)	635 (25.0)
	Width	mm (in)	344 (13.5)
	Depth	mm (in)	246 (9.7)
Net Weight - Antenna Only		kg (lbs)	8.2 (18)
Windload	Calculation	km/h (mph)	160 (100)
	Frontal	N (lbf)	262 (59)
	Side	N (lbf)	107 (24)
Survival Wind Speed		km/h (mph)	241 (150)
Wind Area		m <sup>2</sup> (ft <sup>2</sup> )	0.21 (2.3)
Connector	Type	---	4.3-10 Female
	Quantity	---	20
	Position	---	Bottom
Radome Color		---	Grey
Operating Temperature		degrees	-40 to +60 C (-40 to +140 F)
Lightning Protection (Grounding Type)		---	Direct Ground

Quoted performance parameters are provided to offer typical, peak or range values only and may vary as a result of normal testing, manufacturing and operational conditions. Extreme operational conditions and/or stress on structural supports is beyond our control. Such conditions may result in damage to this product. Improvements to products may be made without notice.

2L4U4VX065X06Fwxys4

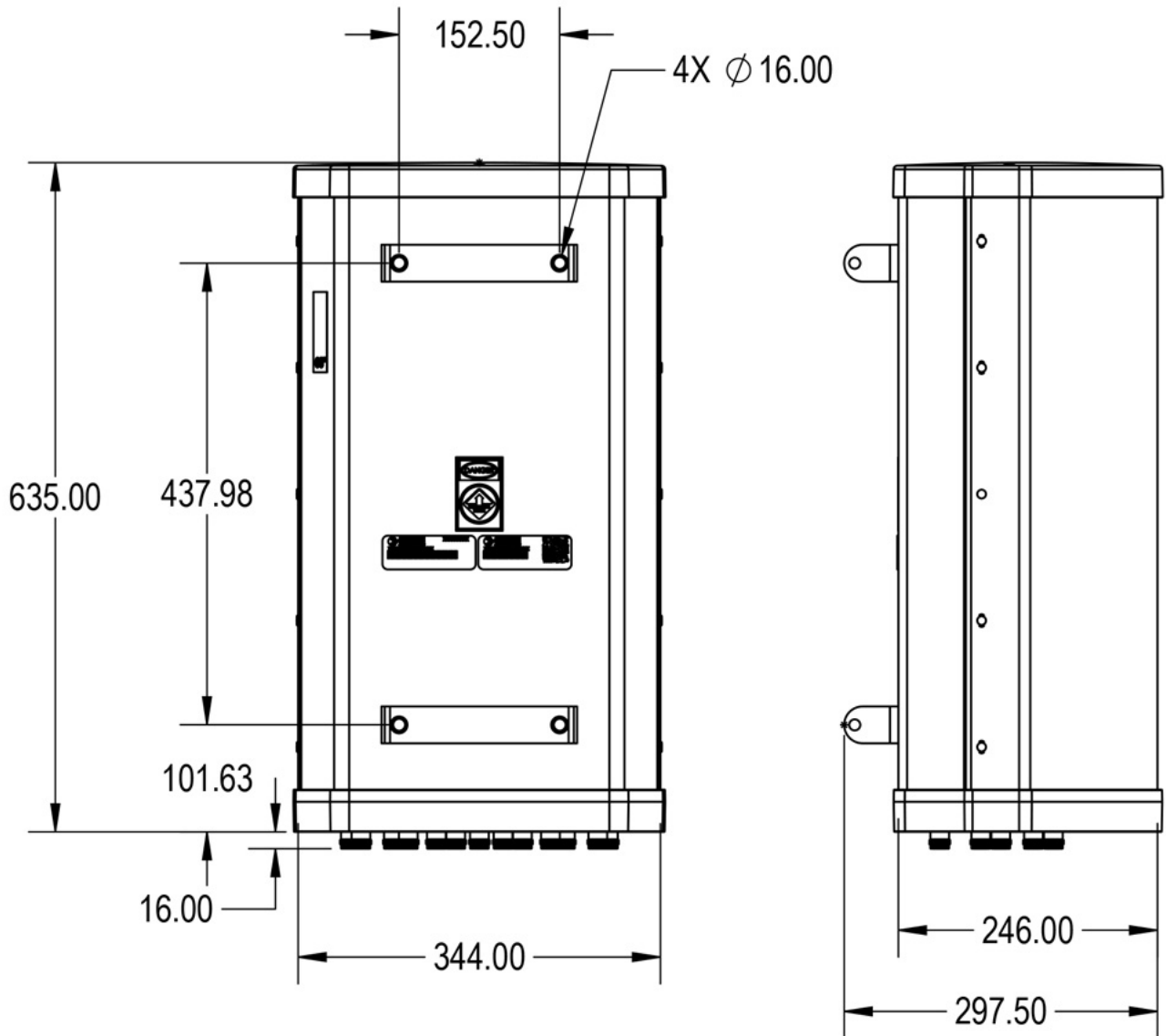

Quoted performance parameters are provided to offer typical, peak or range values only and may vary as a result of normal testing, manufacturing and operational conditions. Extreme operational conditions and/or stress on structural supports is beyond our control. Such conditions may result in damage to this product. Improvements to products may be made without notice.

## 2L4U4VX065X06Fwxys4

### ARRAY LAYOUT Topology

FREQUENCY	ARRAY	CONNECTOR	CONNECTOR TYPE
617-906 MHz	<span style="color: red;">■</span> R1	1-2	(2x) 4.3-10 Female
617-906 MHz	<span style="color: red;">■</span> R2	3-4	(2x) 4.3-10 Female
1695-2700 MHz	<span style="color: yellow;">■</span> Y1	5-6	(2x) 4.3-10 Female
1695-2700 MHz	<span style="color: yellow;">■</span> Y2	7-8	(2x) 4.3-10 Female
1695-2700 MHz	<span style="color: yellow;">■</span> Y3	9-10	(2x) 4.3-10 Female
1695-2700 MHz	<span style="color: yellow;">■</span> Y4	11-12	(2x) 4.3-10 Female
3300-4200 MHz	<span style="color: purple;">■</span> P1	13-14	(2x) 4.3-10 Female
3300-4200 MHz	<span style="color: purple;">■</span> P2	15-16	(2x) 4.3-10 Female
3300-4200 MHz	<span style="color: purple;">■</span> P3	17-18	(2x) 4.3-10 Female
3300-4200 MHz	<span style="color: purple;">■</span> P4	19-20	(2x) 4.3-10 Female

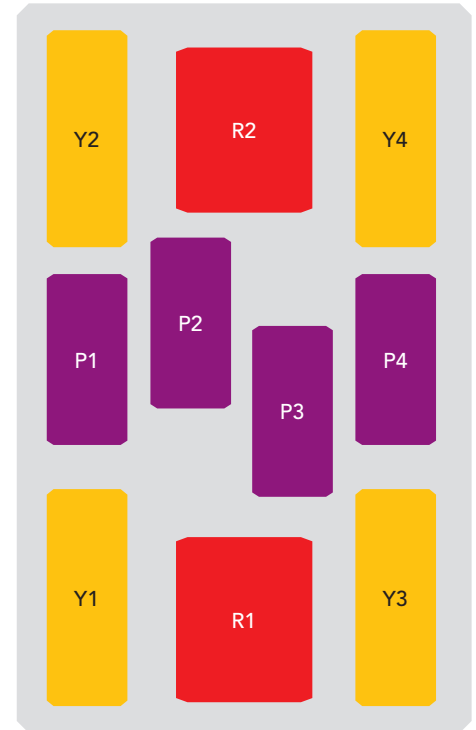

The illustration is not shown to scale.

Quoted performance parameters are provided to offer typical, peak or range values only and may vary as a result of normal testing, manufacturing and operational conditions. Extreme operational conditions and/or stress on structural supports is beyond our control. Such conditions may result in damage to this product. Improvements to products may be made without notice.

# 2L4U4VX065X06Fwxys4

## CONNECTOR VIEW - LABELING

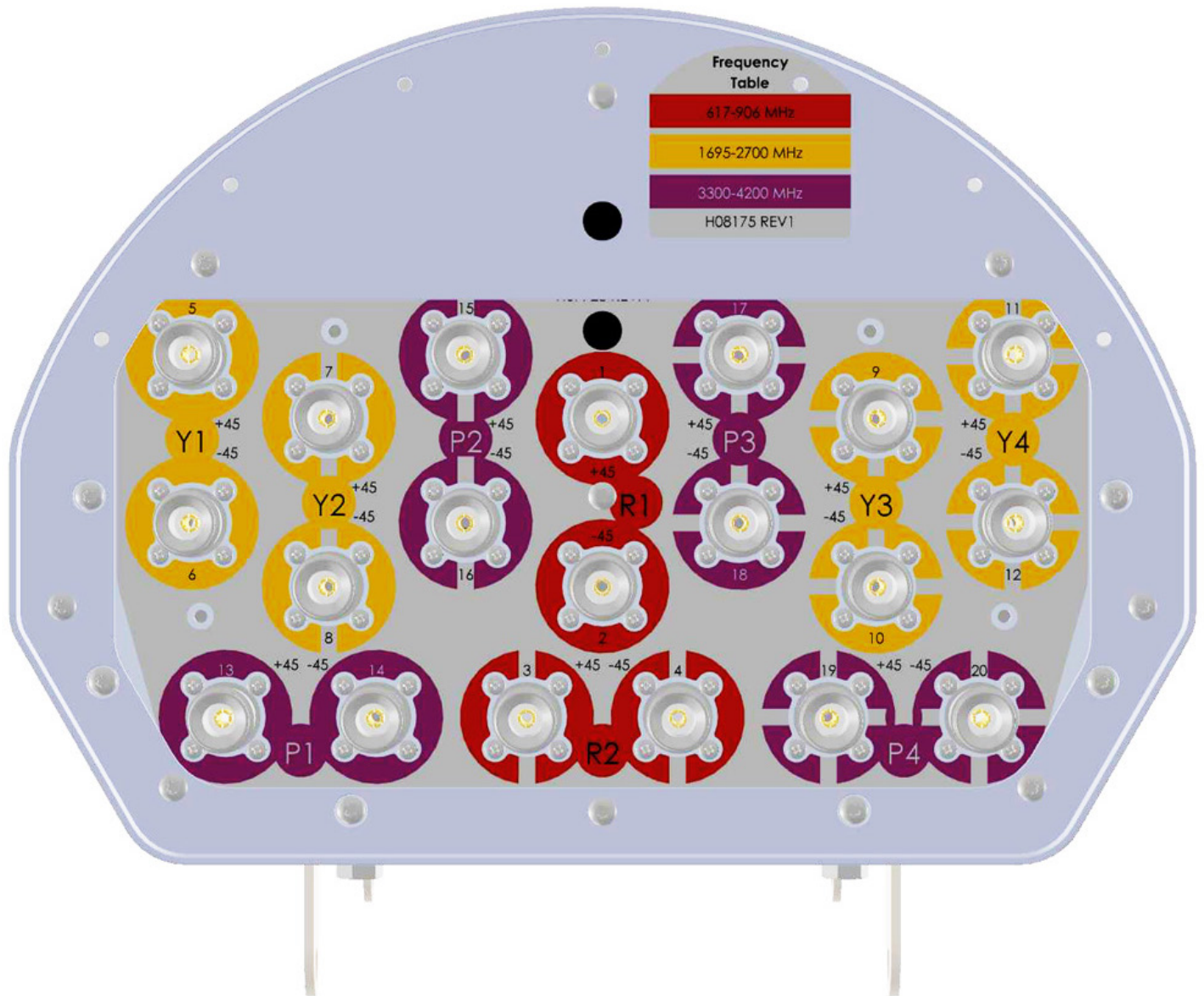

Quoted performance parameters are provided to offer typical, peak or range values only and may vary as a result of normal testing, manufacturing and operational conditions. Extreme operational conditions and/or stress on structural supports is beyond our control. Such conditions may result in damage to this product. Improvements to products may be made without notice.

## 2L4U4VX065X06Fwxys4

**MOUNTING KITS** Select from the following mounting options when ordering.

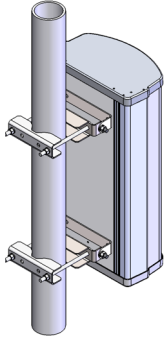
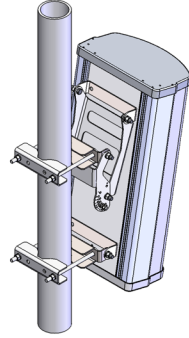
MODEL NUMBER	DESCRIPTION	FITS PIPE DIAMETER	WEIGHT
MKS09P01	 <p>2-POINT MOUNTING BRACKET KIT</p>	50-115 mm (2.0-4.5 in)	2.9 kg (6 lbs)
MKS09T01	 <p>2-POINT, SCISSOR TILT, MOUNTING &amp; DOWNTILT BRACKET KIT</p>	50-115 mm (2.0-4.5 in)	4.5 kg (10 lbs)

 The antennas shown in the mounting kit illustrations above are generic representations and may not resemble the antenna described within this data sheet.

**INSTALLATION** Please read all installation notes before installing this product.

	Always attach the antenna using all mounting points.
	Do not install the antenna with the connectors facing upwards.

Quoted performance parameters are provided to offer typical, peak or range values only and may vary as a result of normal testing, manufacturing and operational conditions. Extreme operational conditions and/or stress on structural supports is beyond our control. Such conditions may result in damage to this product. Improvements to products may be made without notice.

## 2L4U4VX065X06FwxyS4

### HOW TO READ THE MODEL NUMBER Each letter and number has meaning.

NUMBER OF BANDS and OPERATING FREQUENCY			PATTERN TYPE	AZIMUTH BMWDTH	POLARIZATION	LENGTH	TILT TYPE	TILT OPTIONS	CONNECTOR TYPE	VARIATION	ORDERING OPTION
2L	4U	4V	X	065	X	06	F	wxy	s	4	-P -T
(2x) 617-906	(4x) 1695-2700	(4x) 3300-4200	Standard Panel Antenna	65°	XPOL	0.6 meters	Fixed Tilt	<p>These letters are placeholders for fixed tilt options.</p> <p>Refer to Electrical Specifications for available tilt options.</p>	4.3-10 Connector	4th generation mechanical package	<p>To order the antenna and mounting kit together as one line item, add a -P for the 2-POINT MOUNTING BRACKET KIT (MKS09P01) or a -T for the 2-POINT, SCISSOR TILT, MOUNTING &amp; DOWNTILT BRACKET KIT (MKS09T01) to the end of the model number.</p> <p>If -P or -T is not added, the bracket kit can be added as a separate line item, or the antenna shipped without a bracket.</p> <p>Refer to the ordering options on the following page for further detail.</p>

Quoted performance parameters are provided to offer typical, peak or range values only and may vary as a result of normal testing, manufacturing and operational conditions. Extreme operational conditions and/or stress on structural supports is beyond our control. Such conditions may result in damage to this product. Improvements to products may be made without notice.



## 2L4U4VX065X06Fwxys4

### ORDERING OPTIONS Select from the following ordering options

SELECT MOUNTING KIT	SELECT DEGREE OF ELECTRICAL DOWNTILT FOR EACH BAND			ORDER MODEL NUMBER
	617-906 MHz	1695-2700 MHz	3300-4200 MHz	
ANTENNA ONLY - NO MOUNTING KIT	0°	2°	0°	2L4U4VX065X06F020s4
	0°	4°	0°	2L4U4VX065X06F040s4
	0°	6°	0°	2L4U4VX065X06F060s4
	0°	Y1 & Y2 = 2°; Y3 & Y4 = 4°	0°	2L4U4VX065X06FAAA4s4
	0°	Y1 & Y2 = 2°; Y3 & Y4 = 6°	0°	2L4U4VX065X06FBBB4s4
	0°	Y1 & Y2 = 4°; Y3 & Y4 = 6°	0°	2L4U4VX065X06FCCC4s4
ANTENNA WITH <b>MKS09P01</b> MOUNTING KIT  2-Point Mounting Bracket Kit	0°	2°	0°	2L4U4VX065X06F020s4-P
	0°	4°	0°	2L4U4VX065X06F040s4-P
	0°	6°	0°	2L4U4VX065X06F060s4-P
	0°	Y1 & Y2 = 2°; Y3 & Y4 = 4°	0°	2L4U4VX065X06FAAA4s4-P
	0°	Y1 & Y2 = 2°; Y3 & Y4 = 6°	0°	2L4U4VX065X06FBBB4s4-P
	0°	Y1 & Y2 = 4°; Y3 & Y4 = 6°	0°	2L4U4VX065X06FCCC4s4-P
ANTENNA WITH <b>MKS09T01</b> MOUNTING KIT  2-Point, Scissor Tilt, Mounting & Downtilt Bracket Kit	0°	2°	0°	2L4U4VX065X06F020s4-T
	0°	4°	0°	2L4U4VX065X06F040s4-T
	0°	6°	0°	2L4U4VX065X06F060s4-T
	0°	Y1 & Y2 = 2°; Y3 & Y4 = 4°	0°	2L4U4VX065X06FAAA4s4-T
	0°	Y1 & Y2 = 2°; Y3 & Y4 = 6°	0°	2L4U4VX065X06FBBB4s4-T
	0°	Y1 & Y2 = 4°; Y3 & Y4 = 6°	0°	2L4U4VX065X06FCCC4s4-T

Quoted performance parameters are provided to offer typical, peak or range values only and may vary as a result of normal testing, manufacturing and operational conditions. Extreme operational conditions and/or stress on structural supports is beyond our control. Such conditions may result in damage to this product. Improvements to products may be made without notice.

## 2L4U4VX065X06Fwxys4

650 MHz ———  
750 MHz ———  
850 MHz ———

**R1, 0° TILT**

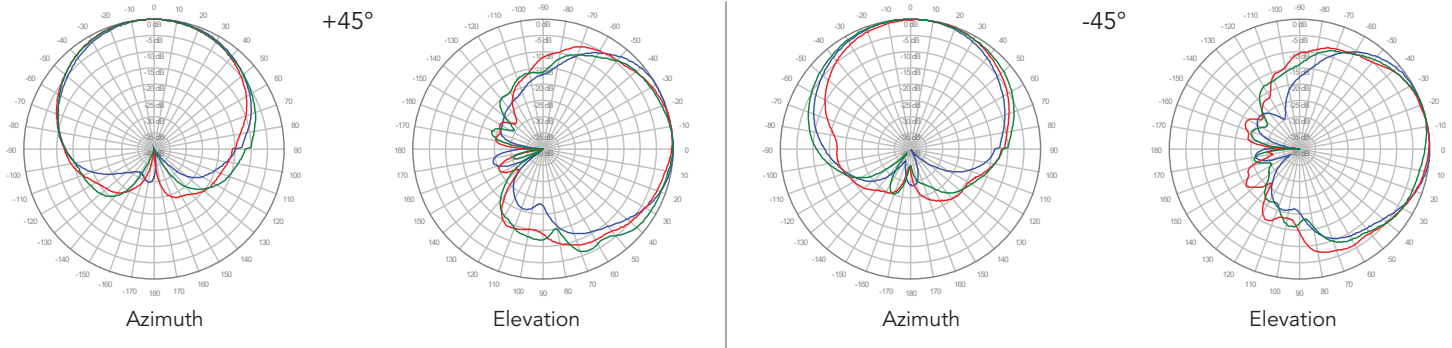

**R2, 0° TILT**

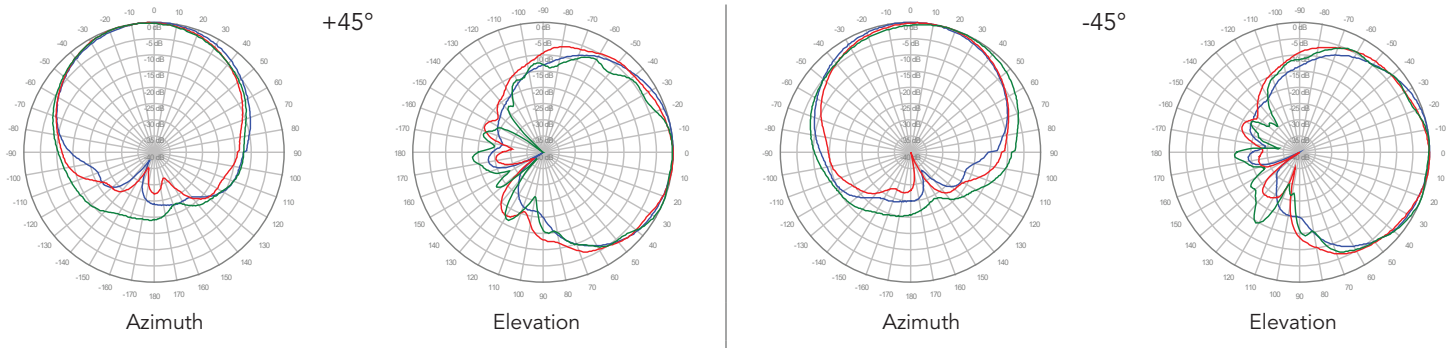

Quoted performance parameters are provided to offer typical, peak or range values only and may vary as a result of normal testing, manufacturing and operational conditions. Extreme operational conditions and/or stress on structural supports is beyond our control. Such conditions may result in damage to this product. Improvements to products may be made without notice.

## 2L4U4VX065X06Fwxys4

- 1800 MHz ———
- 1900 MHz ———
- 2100 MHz ———
- 2300 MHz ———
- 2600 MHz ———

**Y1, 2° TILT**

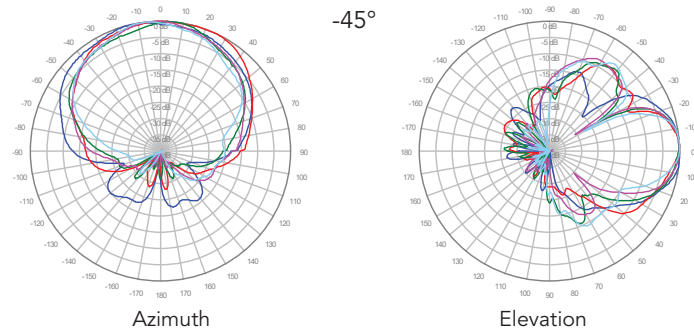
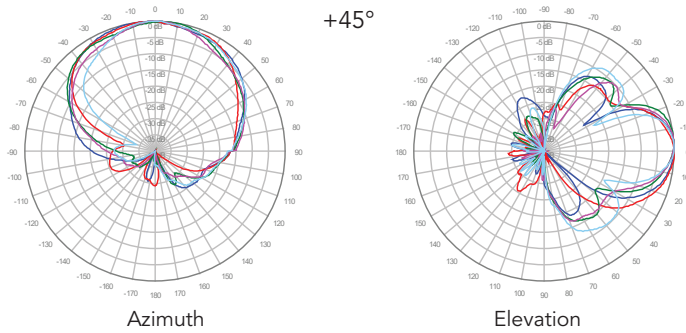

**Y2, 2° TILT**

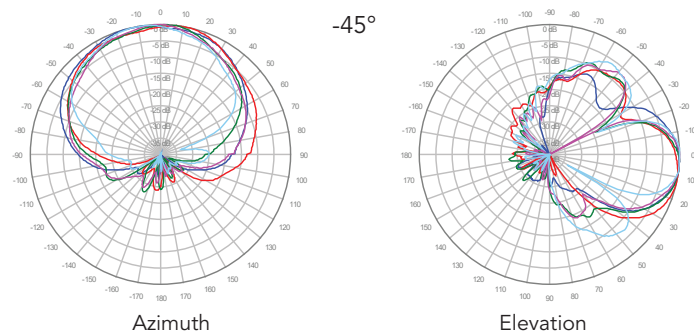
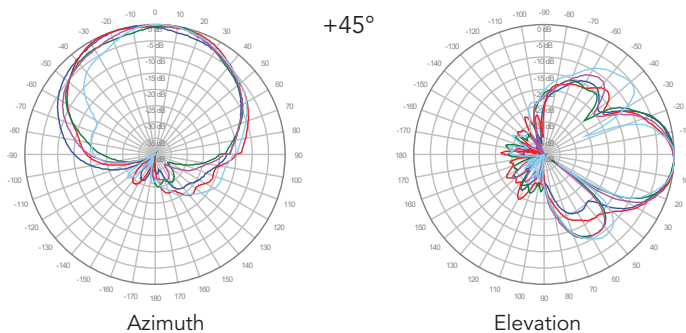

**Y3, 2° TILT**

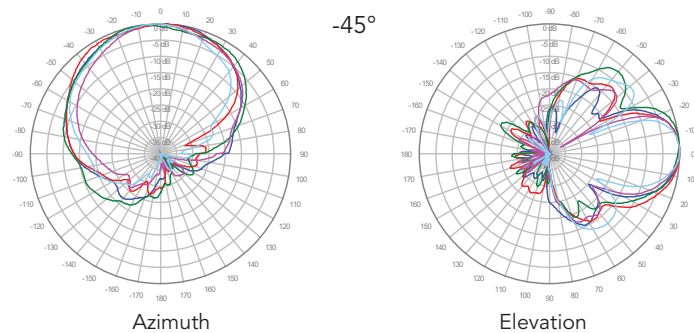
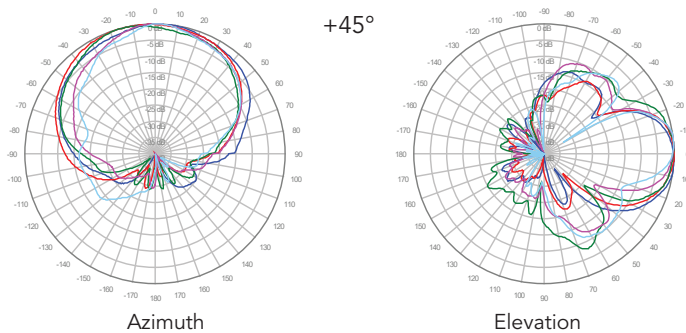

**Y4, 2° TILT**

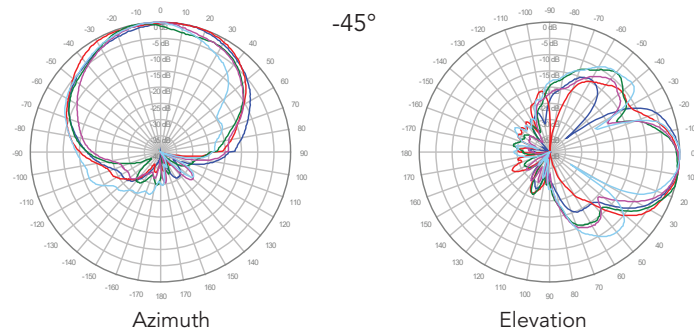
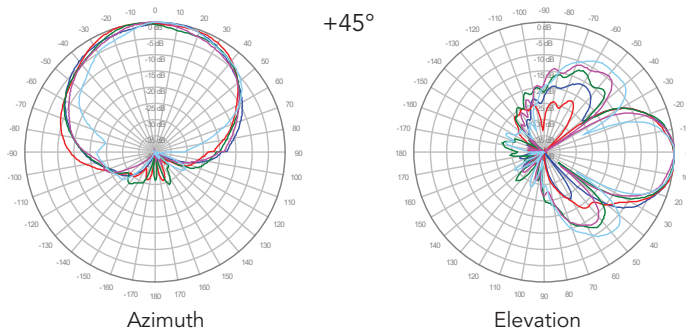

Quoted performance parameters are provided to offer typical, peak or range values only and may vary as a result of normal testing, manufacturing and operational conditions. Extreme operational conditions and/or stress on structural supports is beyond our control. Such conditions may result in damage to this product. Improvements to products may be made without notice.

## 2L4U4VX065X06Fwxys4

- 1800 MHz ———
- 1900 MHz ———
- 2100 MHz ———
- 2300 MHz ———
- 2600 MHz ———

**■ Y1, 4° TILT**

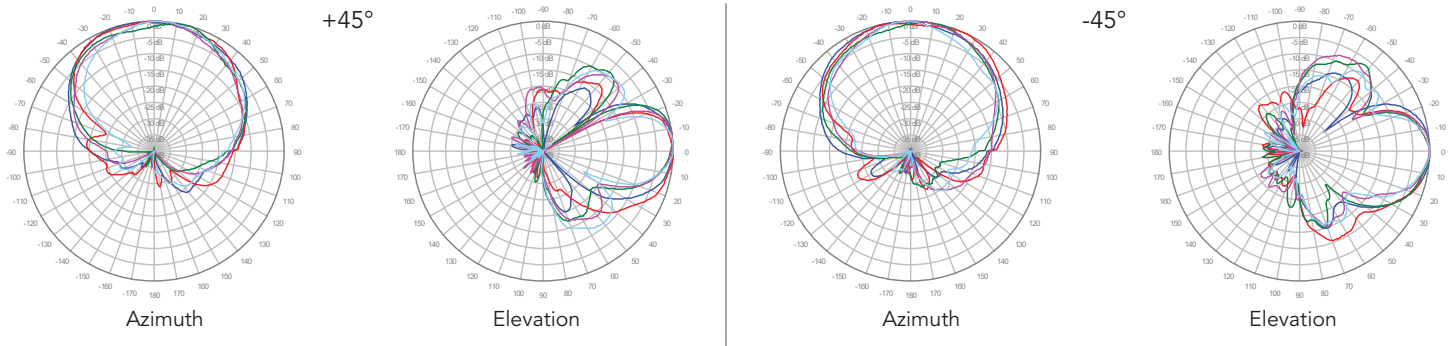

**■ Y2, 4° TILT**

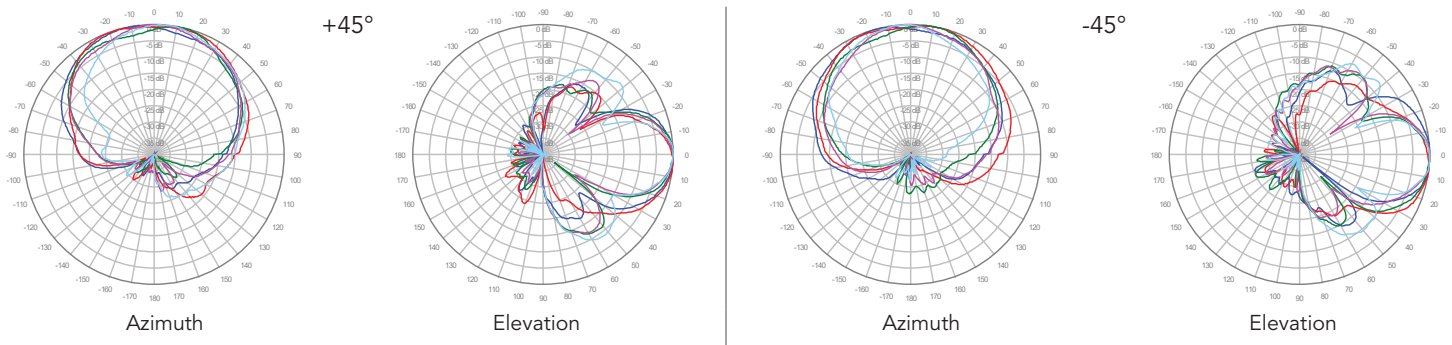

**■ Y3, 4° TILT**

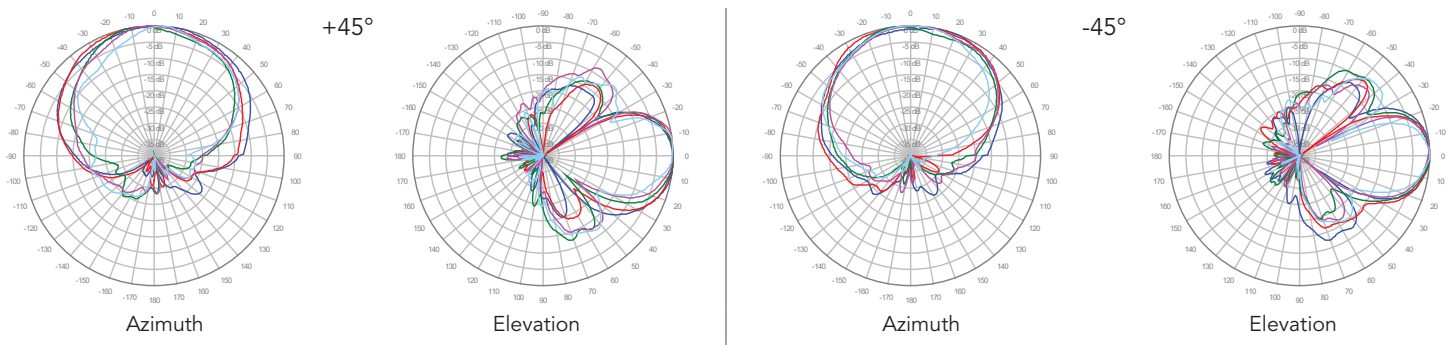

**■ Y4, 4° TILT**

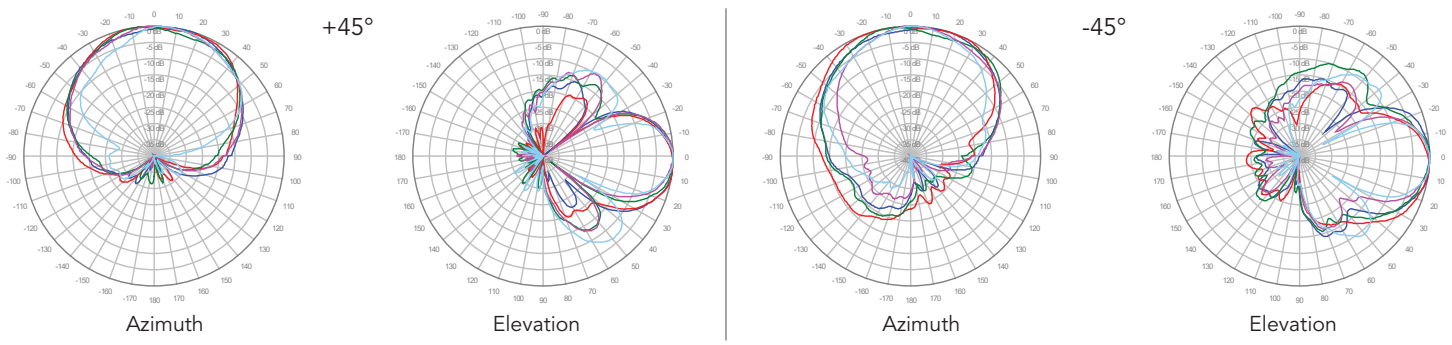

Quoted performance parameters are provided to offer typical, peak or range values only and may vary as a result of normal testing, manufacturing and operational conditions. Extreme operational conditions and/or stress on structural supports is beyond our control. Such conditions may result in damage to this product. Improvements to products may be made without notice.

## 2L4U4VX065X06Fwxys4

- 1800 MHz ———
- 1900 MHz ———
- 2100 MHz ———
- 2300 MHz ———
- 2600 MHz ———

**Y1, 6° TILT**

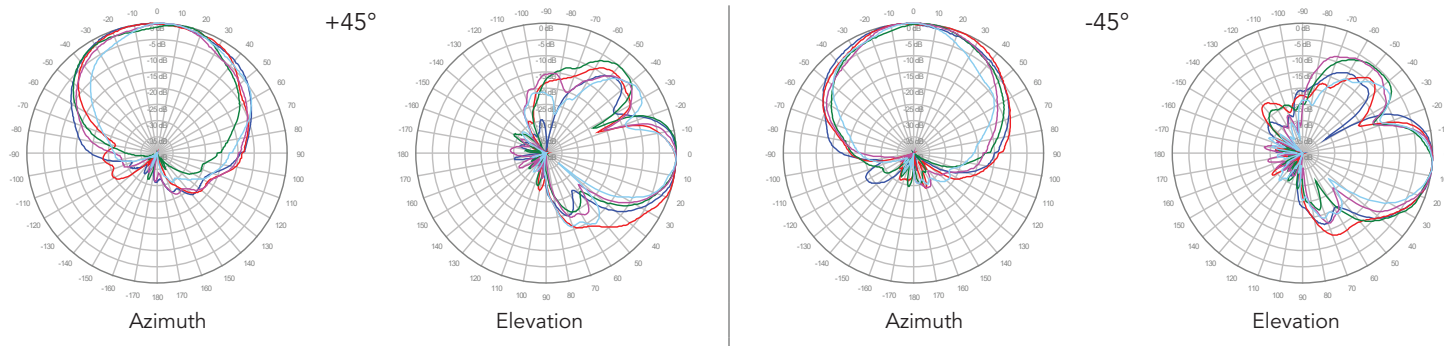

**Y2, 6° TILT**

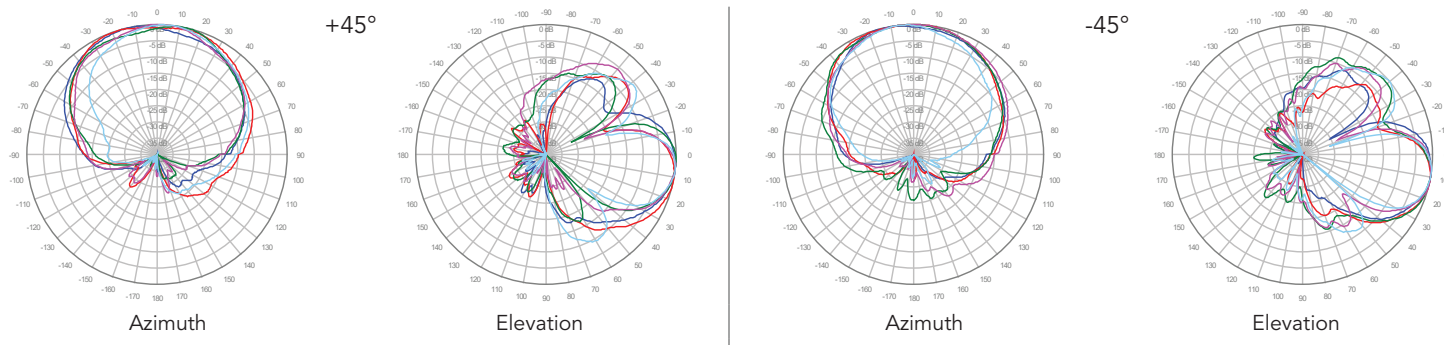

**Y3, 6° TILT**

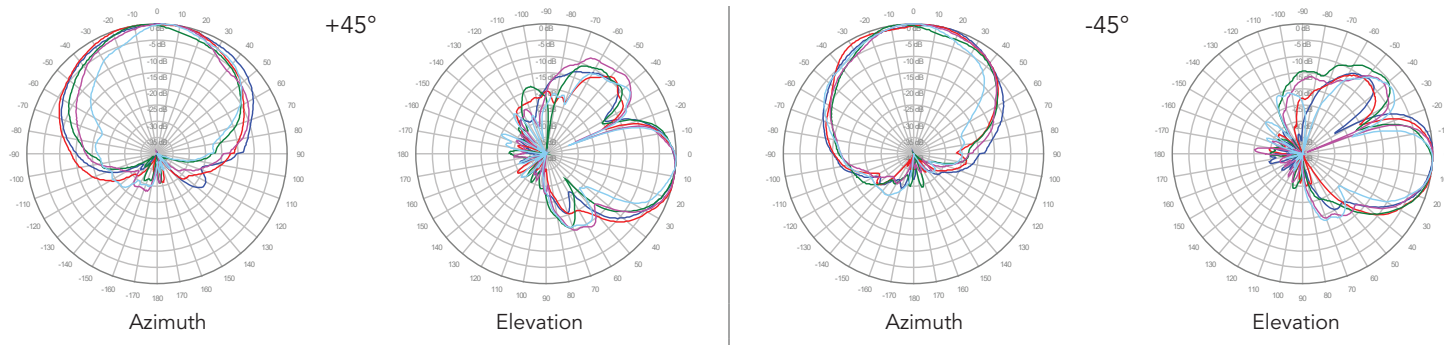

**Y4, 6° TILT**

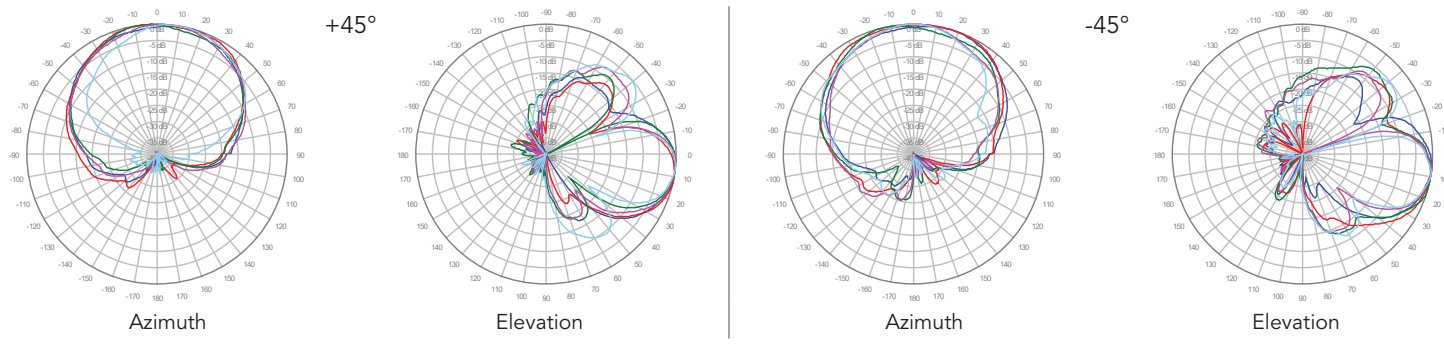

Quoted performance parameters are provided to offer typical, peak or range values only and may vary as a result of normal testing, manufacturing and operational conditions. Extreme operational conditions and/or stress on structural supports is beyond our control. Such conditions may result in damage to this product. Improvements to products may be made without notice.

## 2L4U4VX065X06Fwxys4

3600 MHz ————  
4000 MHz ————

**P1, 0° TILT**

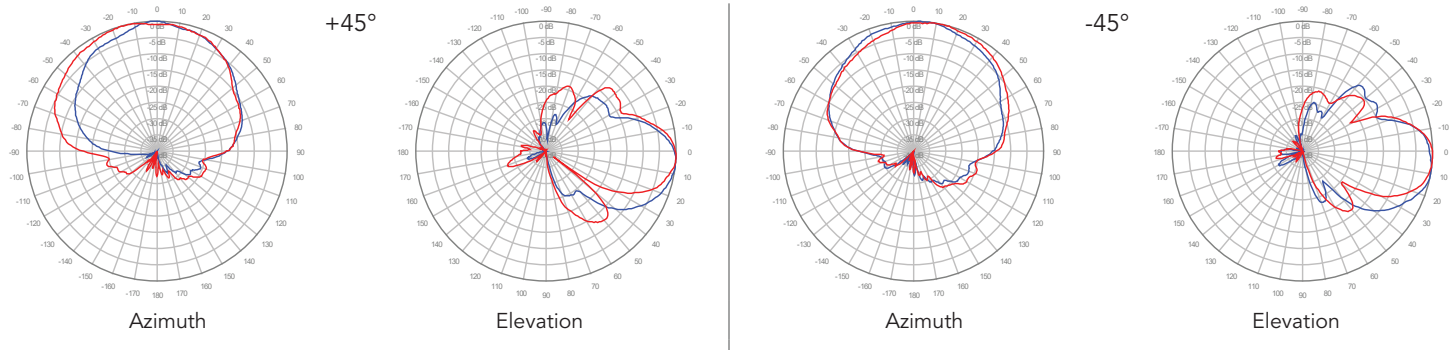

**P2, 0° TILT**

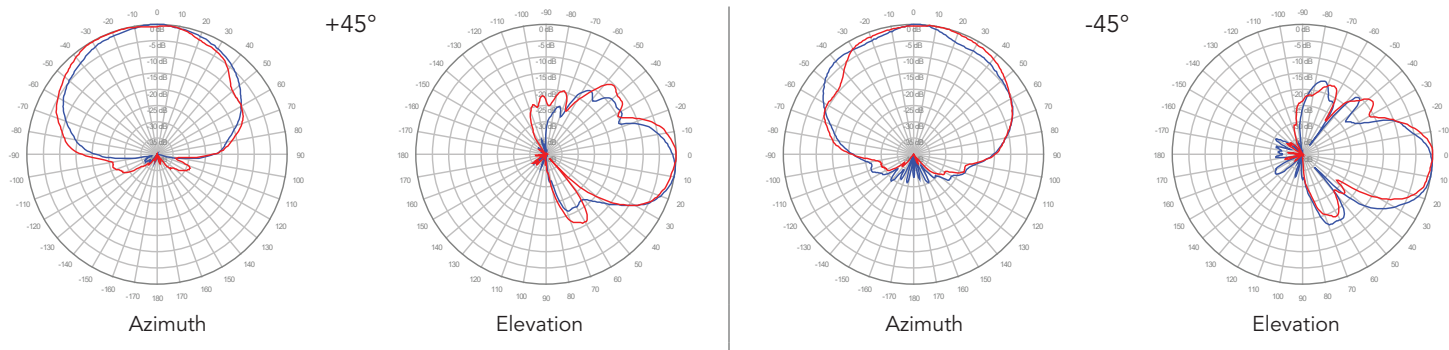

**P3, 0° TILT**

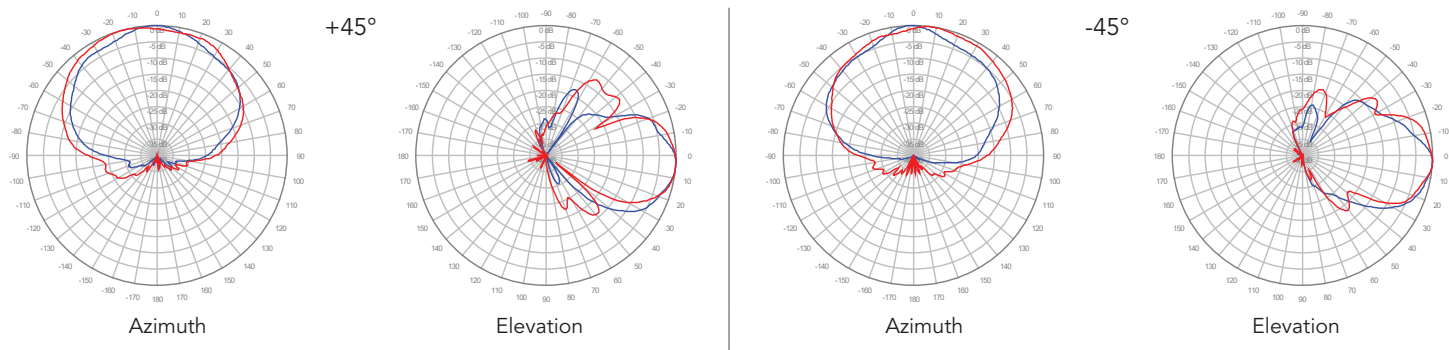

**P4, 0° TILT**

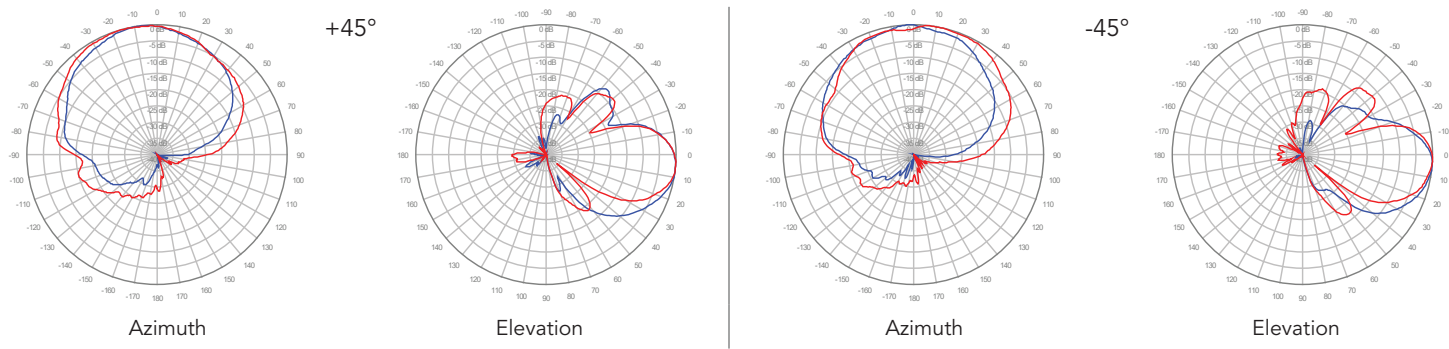

Quoted performance parameters are provided to offer typical, peak or range values only and may vary as a result of normal testing, manufacturing and operational conditions. Extreme operational conditions and/or stress on structural supports is beyond our control. Such conditions may result in damage to this product. Improvements to products may be made without notice.